



by PACIFIC ARCHITECTURAL MILLWORK

Slimline Standard Inswing Door WA8400

(rev. 02.06.18)

Slimline Standard Inswing Door WA8400

Section Contents

Product Overview	3
Introduction	3
Hardware Options	3
Glazing Options	3
Wood Species	3
Hardware Images	3
Product Parameters	3
Single Hinged Inswing: Exterior Elevation.....	4
Double Hinged Inswing: Exterior Elevation.....	5
Standard Inswing: Head Detail.....	6
Standard Inswing: Sill Detail.....	7
Standard Inswing: Jamb Detail (Hinge Side)	8
Standard Inswing: Jamb Detail (Strike Side)	9
Standard Inswing: Meeting Detail.....	10
Fixed Standard Inswing: Head Detail	11
Fixed Standard Inswing: Sill Detail	12
Fixed Standard Inswing: Typical Jamb Detail	13
Fixed Standard Inswing: Meeting Detail	14
Contemporary SDL Detail.....	15

Product Overview

Introduction

The Slimline Standard Inswing Door WA8400 combines the clean, minimal sight lines of all-aluminum or steel doors with the natural beauty and superior thermal performance of wood. This contemporary stile-and-rail door is clad on the exterior with durable, heavy-gauge extruded aluminum and finished with a custom color-matched Kynar paint, for reduced maintenance and maximum protection against fading and corrosion. Each door is pre-hung and precision-built by master craftsmen, resulting in premium quality and beauty you can see and feel.

This “Standard” version of the Slimline Inswing Door refers to the variable-depth jamb and frame and panel profiles that are typical of North American inswing door products. The Slimline Door is available in both single and double door configurations. See relevant product ADMs for more details regarding Slimline Doors with outswing or “Euro” inswing operation.

Hardware Options

Doors are pre-hung on brass hinges, in either Oil-Rubbed Bronze or Satin Nickel finish.

Due to the narrow stiles, handle and escutcheon options are limited. Contact Reveal Windows & Doors for more details.

Glazing Options

Standard glazing for the optional glass panel uses 1 1/8” overall tempered insulated glass. Custom glazing, tinted glass, and clad panels are also available.

Due to the narrow stiles and rails, the interior wood edge detail and exterior clad profile is Contemporary only.

Exterior clad profile is contemporary only.

Wood Species

Our standard wood species are the following:





- Pine
- Vertical Grain Douglas Fir
- African Mahogany

Alternative and exotic wood species are also available. See the Wood Species page in the

Other Options

Contact Reveal Windows & Doors for additional options and customization.

Hardware Images

	
London Handle (Standard)	Verona Handle (Optional)
<ul style="list-style-type: none"> • Silver • Grey Brown • Traffic White 	<ul style="list-style-type: none"> • Resista Brass • Oil-Rubbed Brass • Satin Nickel

Product Parameters

Max Frame Height	120"
Max Frame Width	43 3/4"
Min Frame Height	66"
Min Frame Width	20"
Panel Thickness	3-5/16"
Stile Width	3"
Min Jamb Depth	4 9/16" (behind nail fin)
Edge Detail	<ul style="list-style-type: none"> • Exterior: Contemporary • Interior: Contemporary* <p>*Adding Contemporary or Traditional grids to the window will require Contemporary edge detail</p>

Single Hinged Inswing: Exterior Elevation

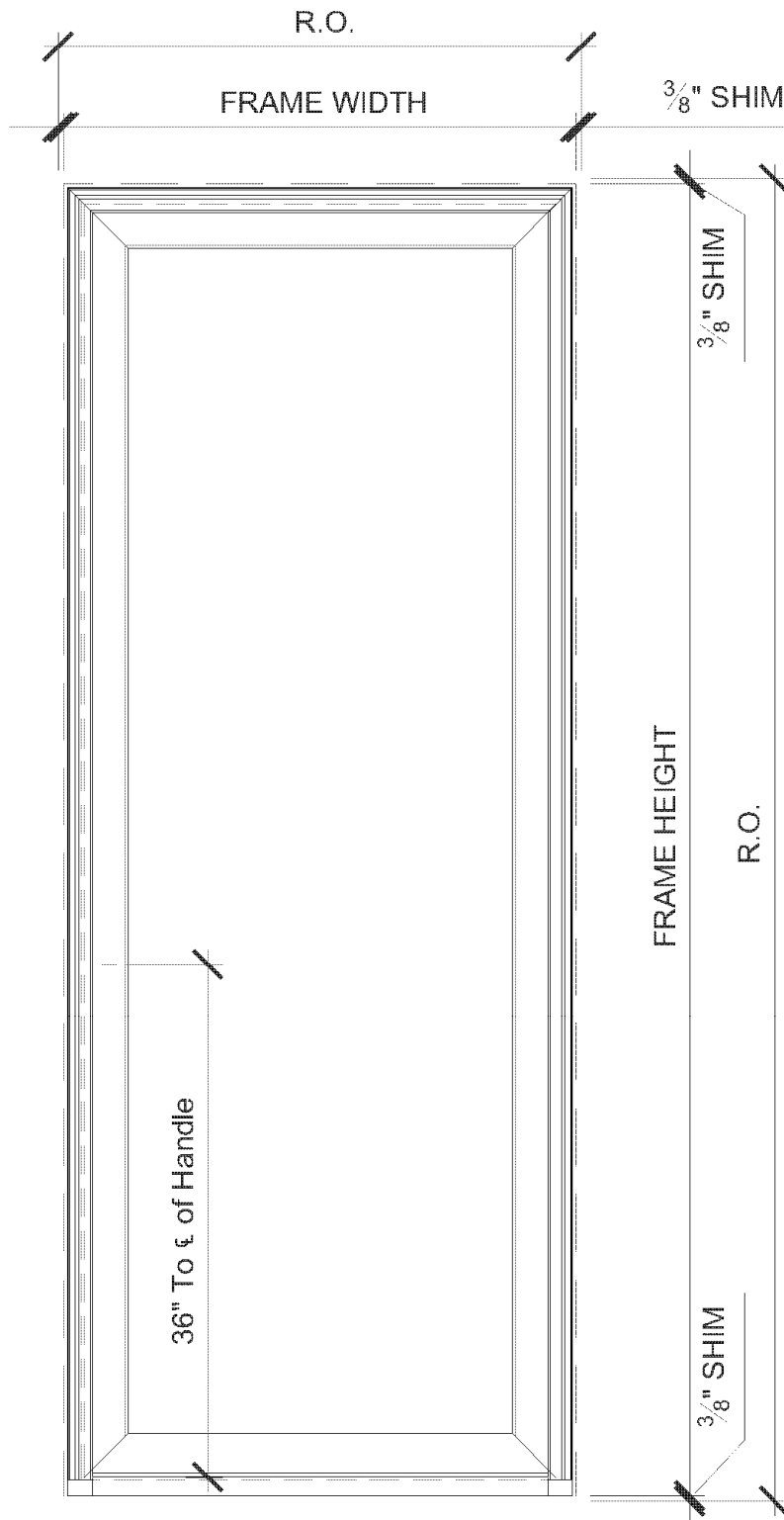

Double Hinged Inswing: Exterior Elevation

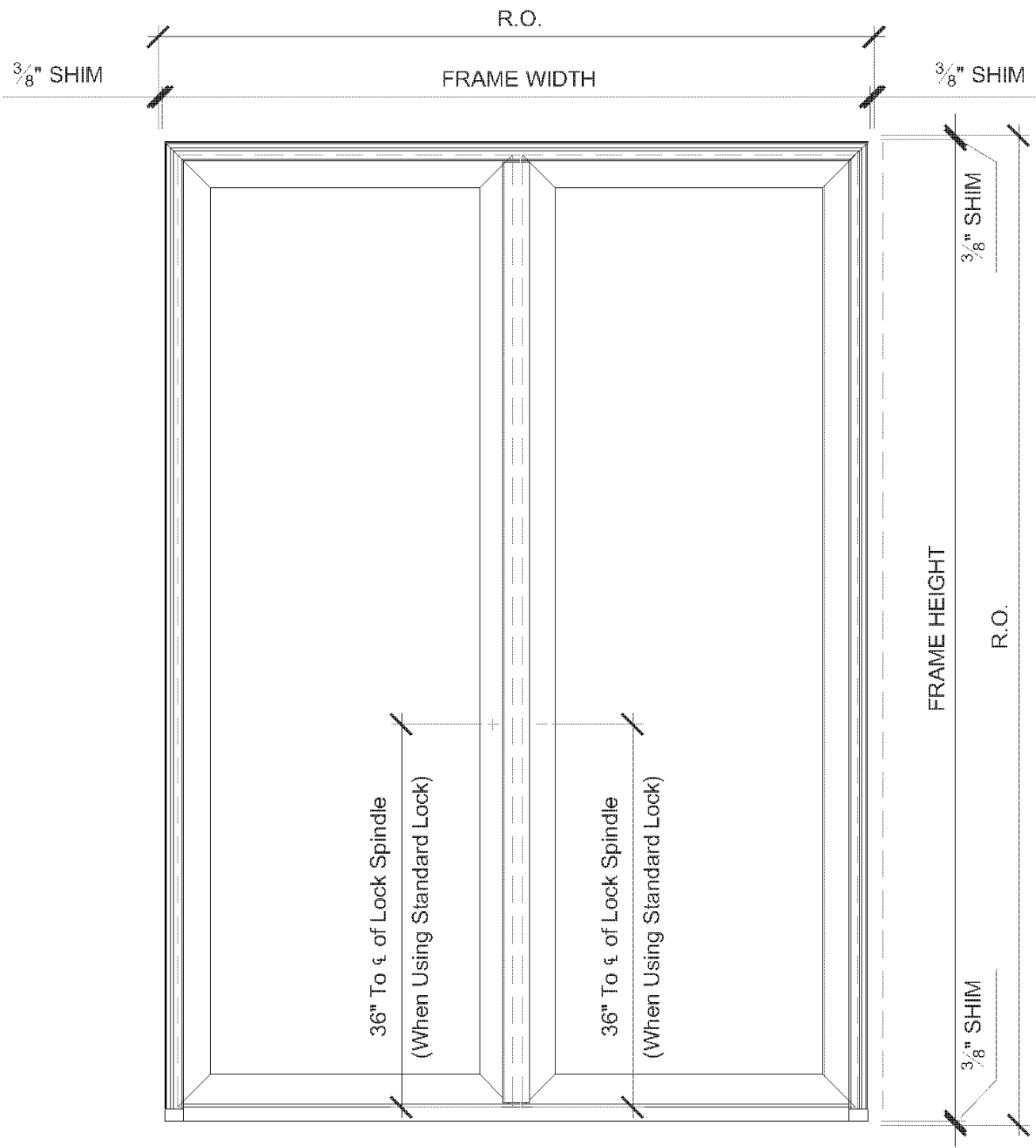

Slimline Standard Inswing Door WA8400

(rev. 02.06.18)

Standard Inswing: Head Detail

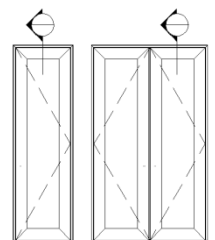
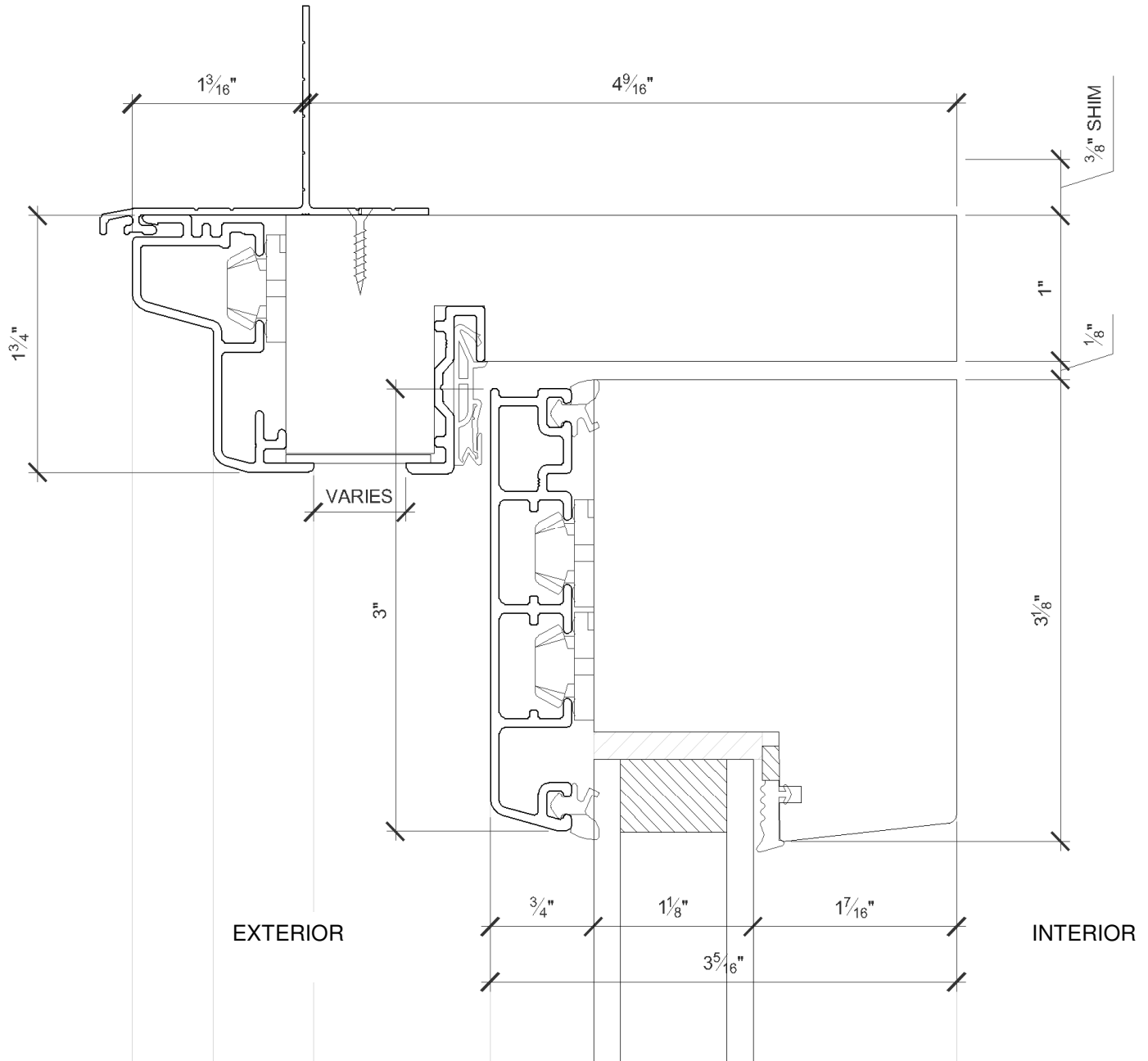

Standard Inswing: Sill Detail

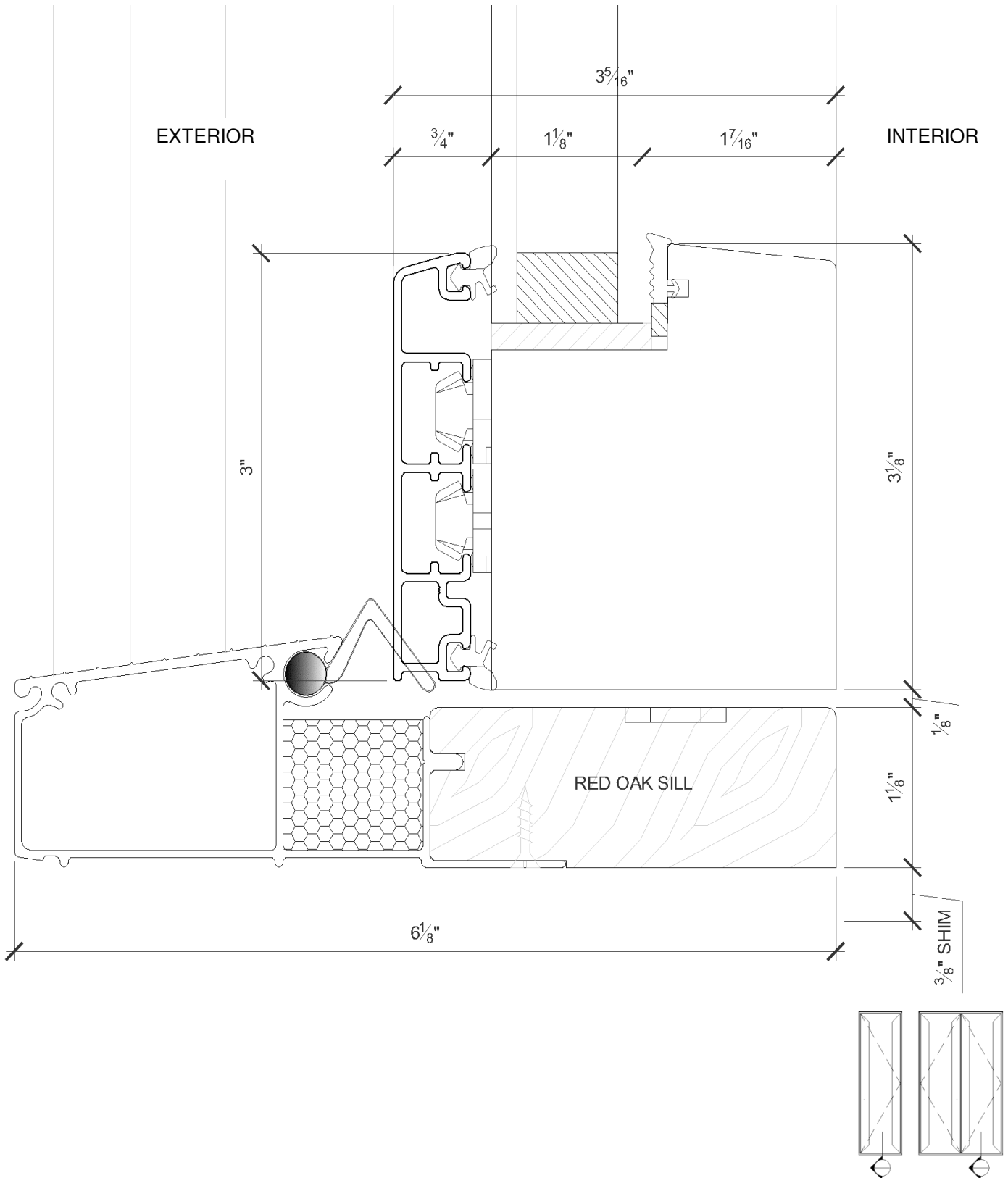

Standard Inswing: Jamb Detail (Hinge Side)

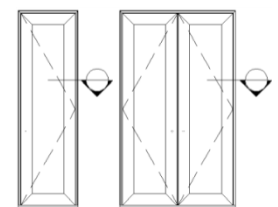
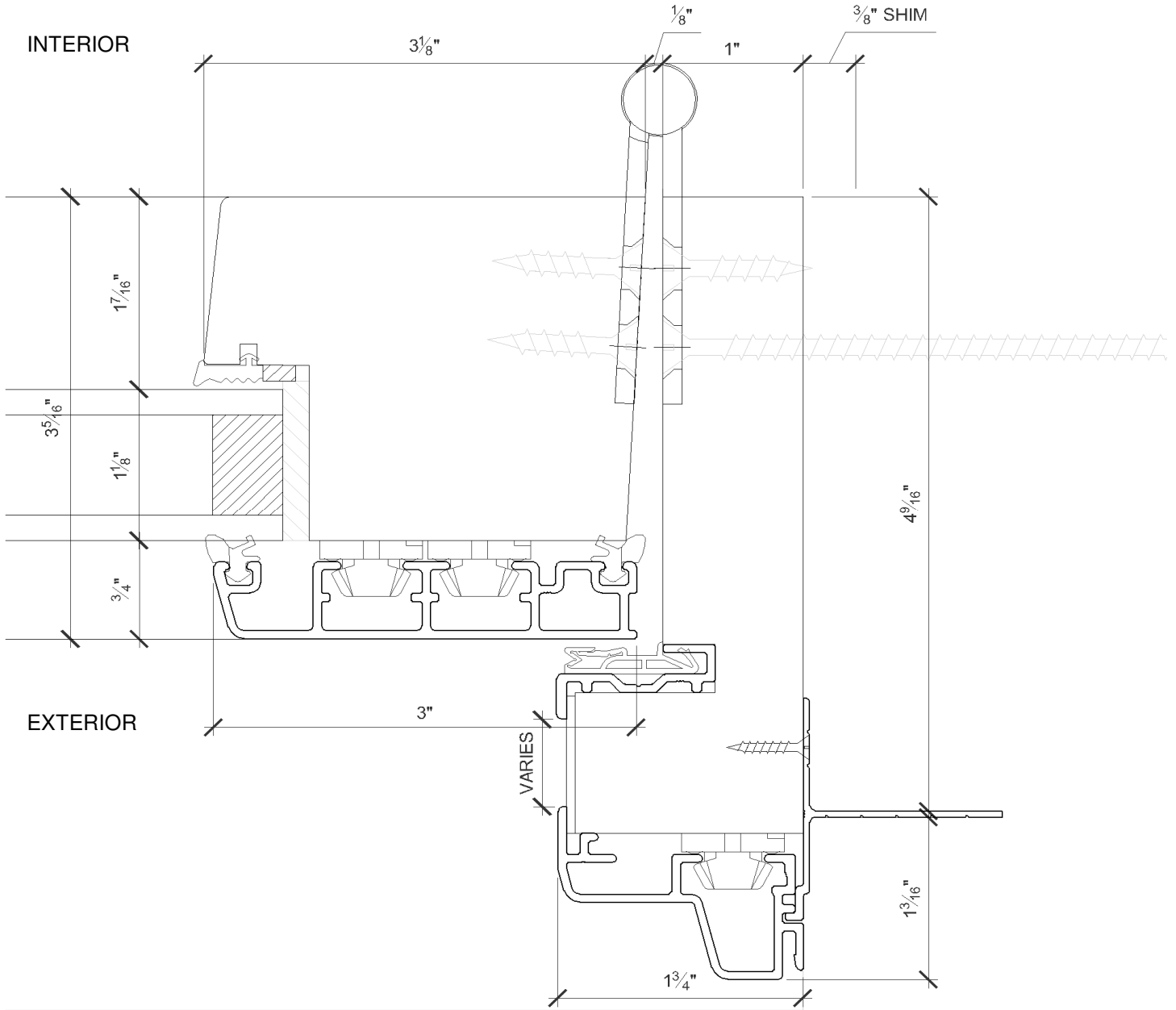

Standard Inswing: Jamb Detail (Strike Side)

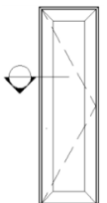
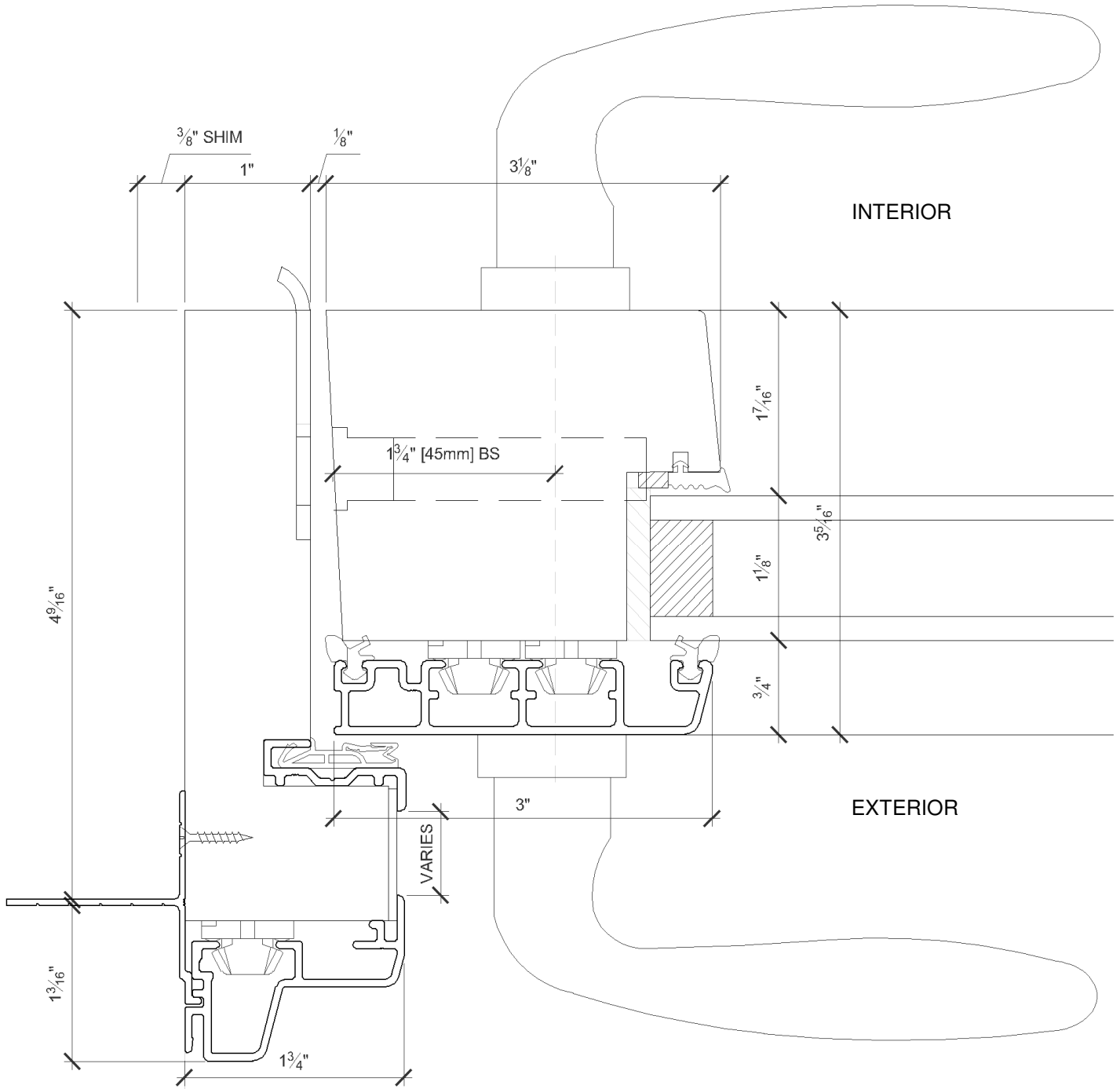

Standard Inswing: Meeting Detail

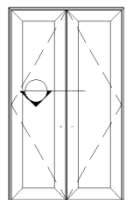
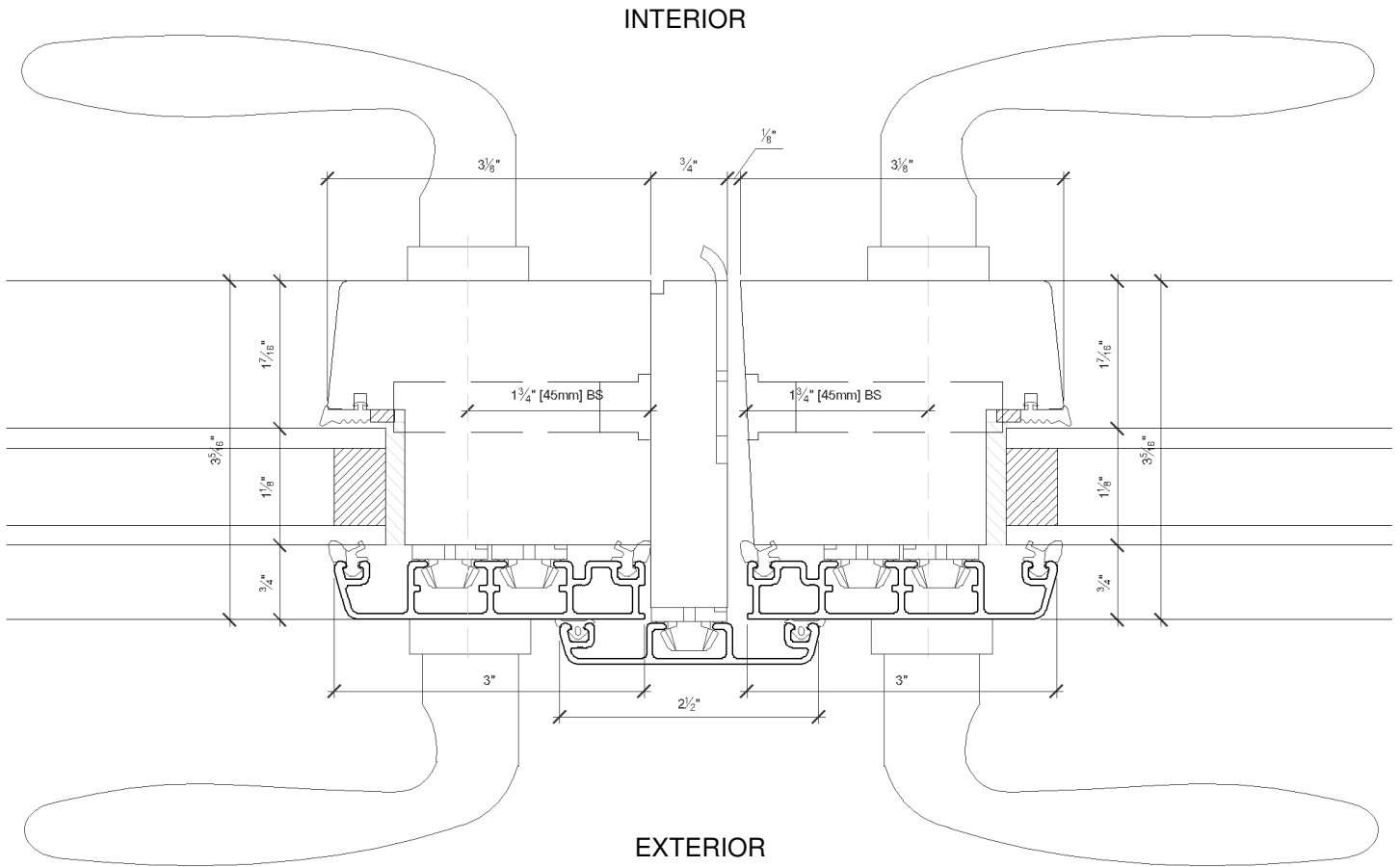

Fixed Standard Inswing: Head Detail

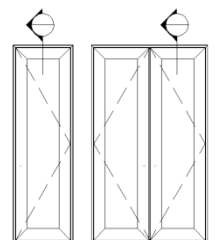
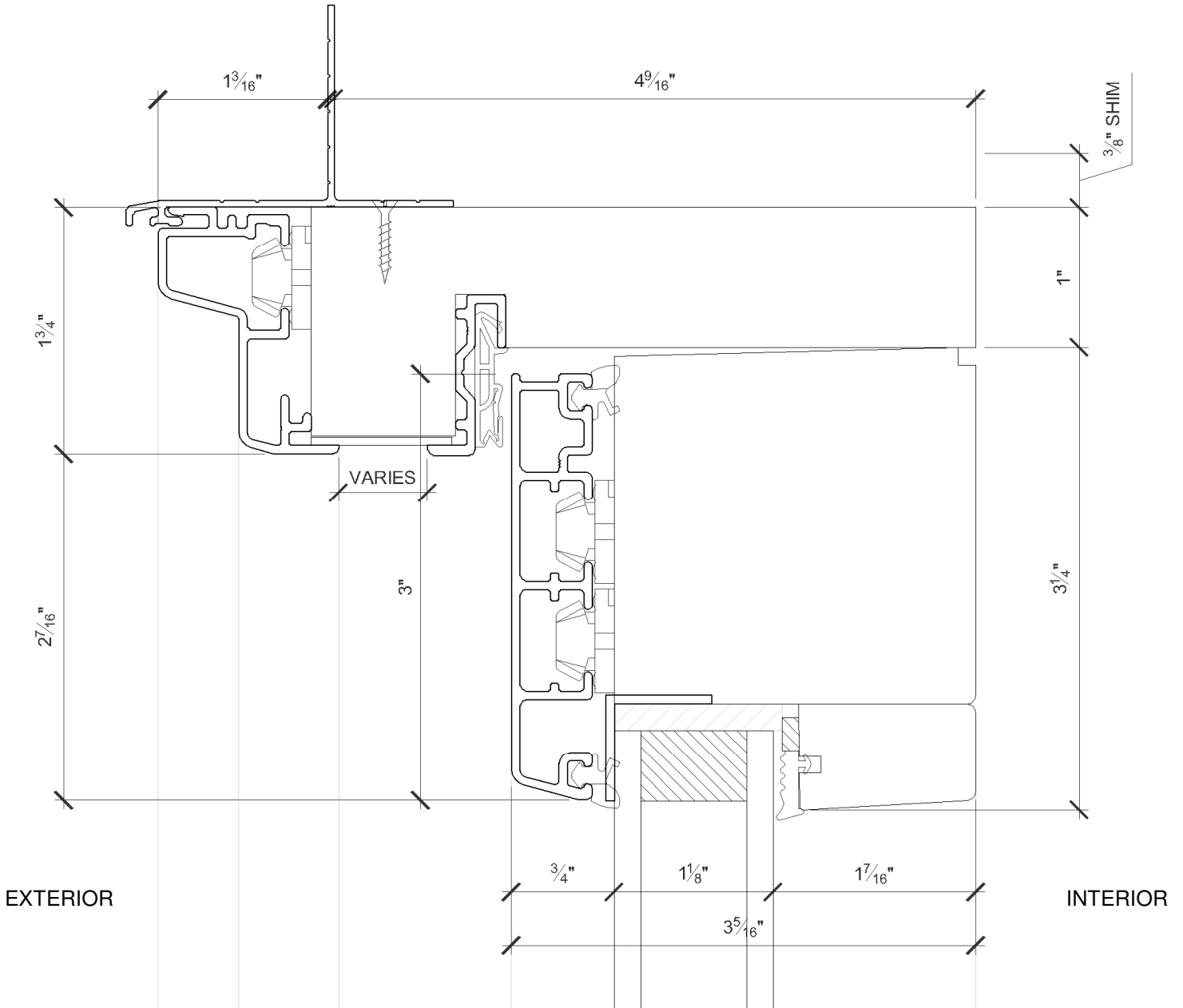

Fixed Standard Inswing: Sill Detail

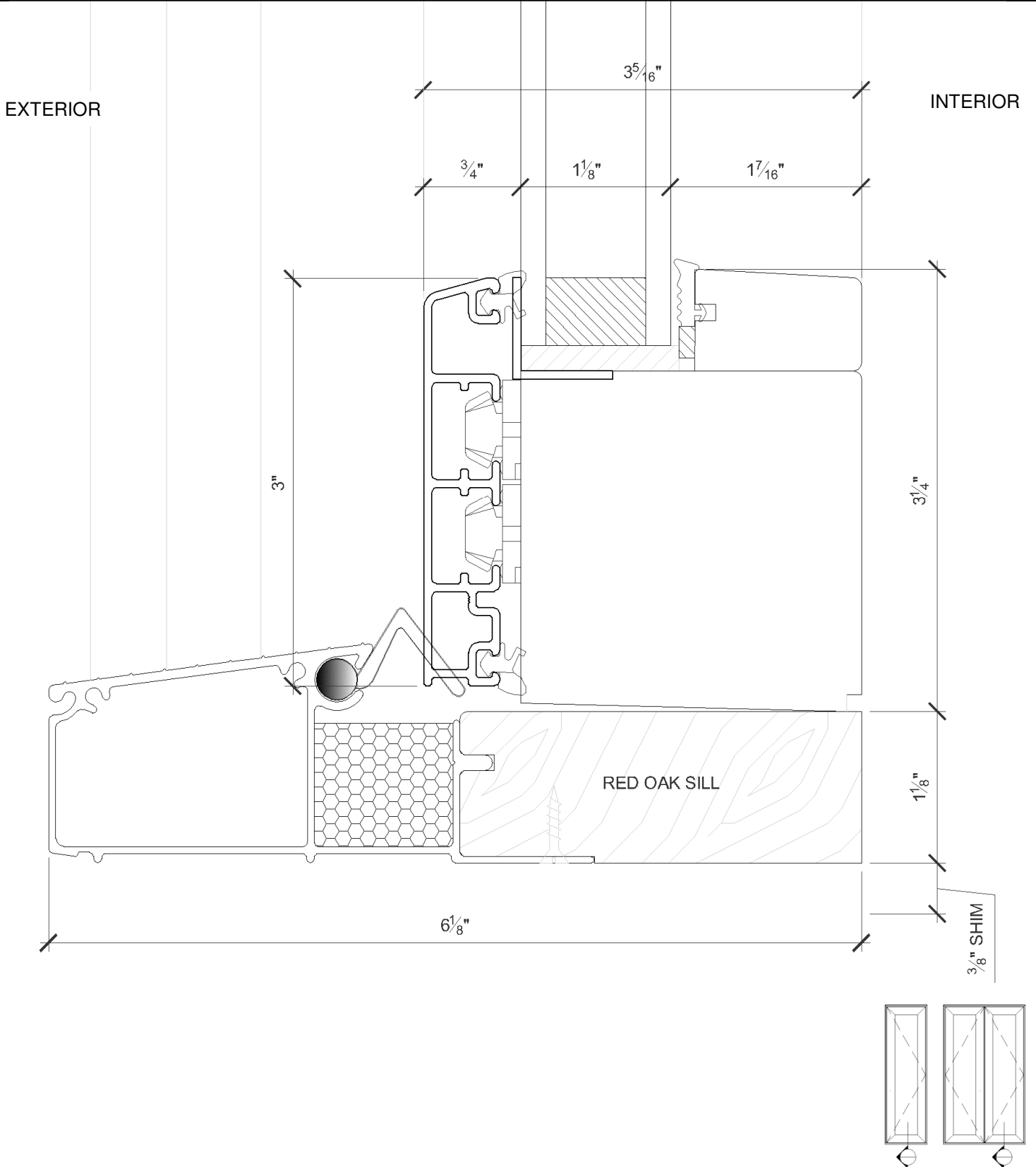

Fixed Standard Inswing: Typical Jamb Detail

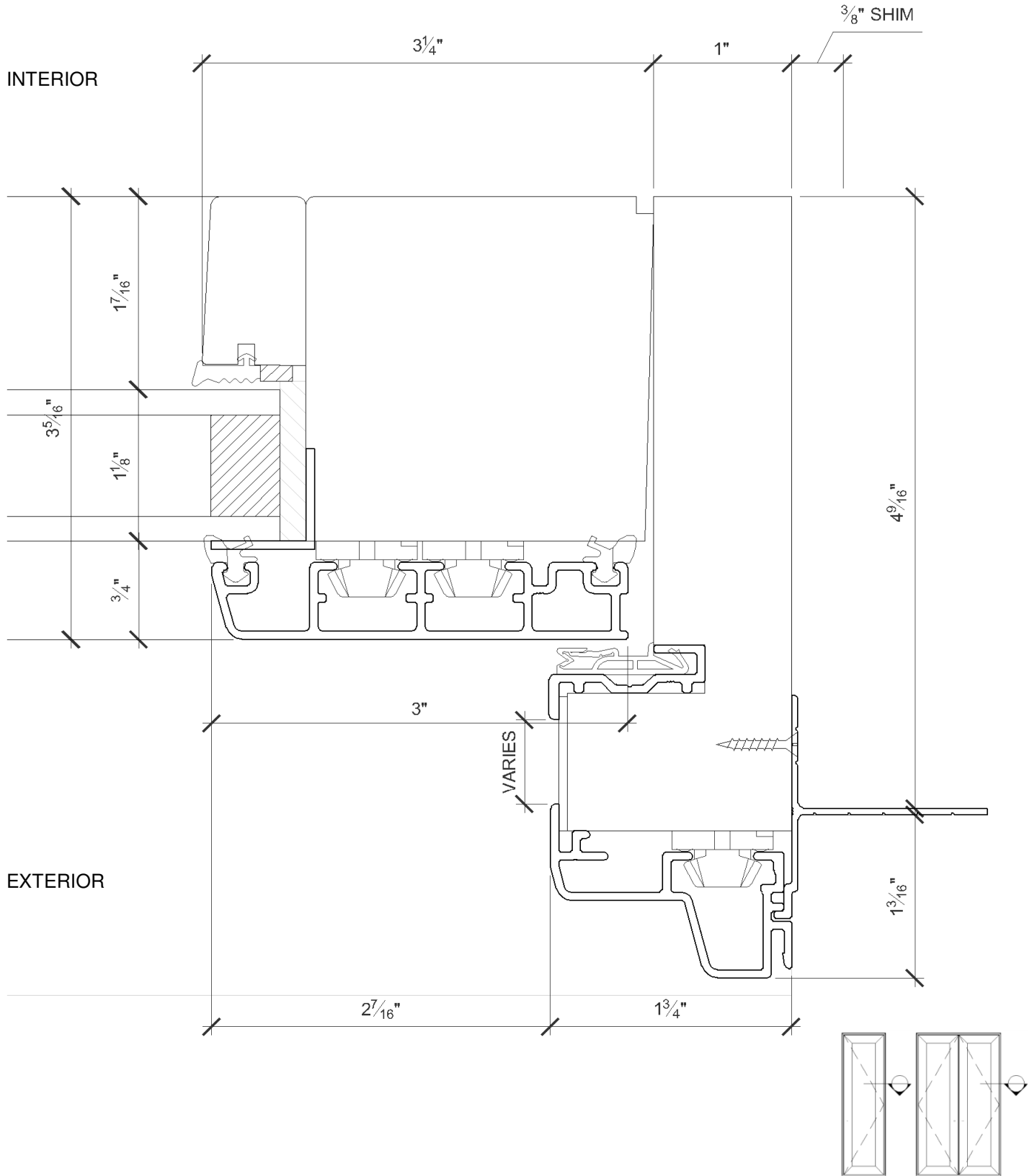

Fixed Standard Inswing: Meeting Detail

INTERIOR

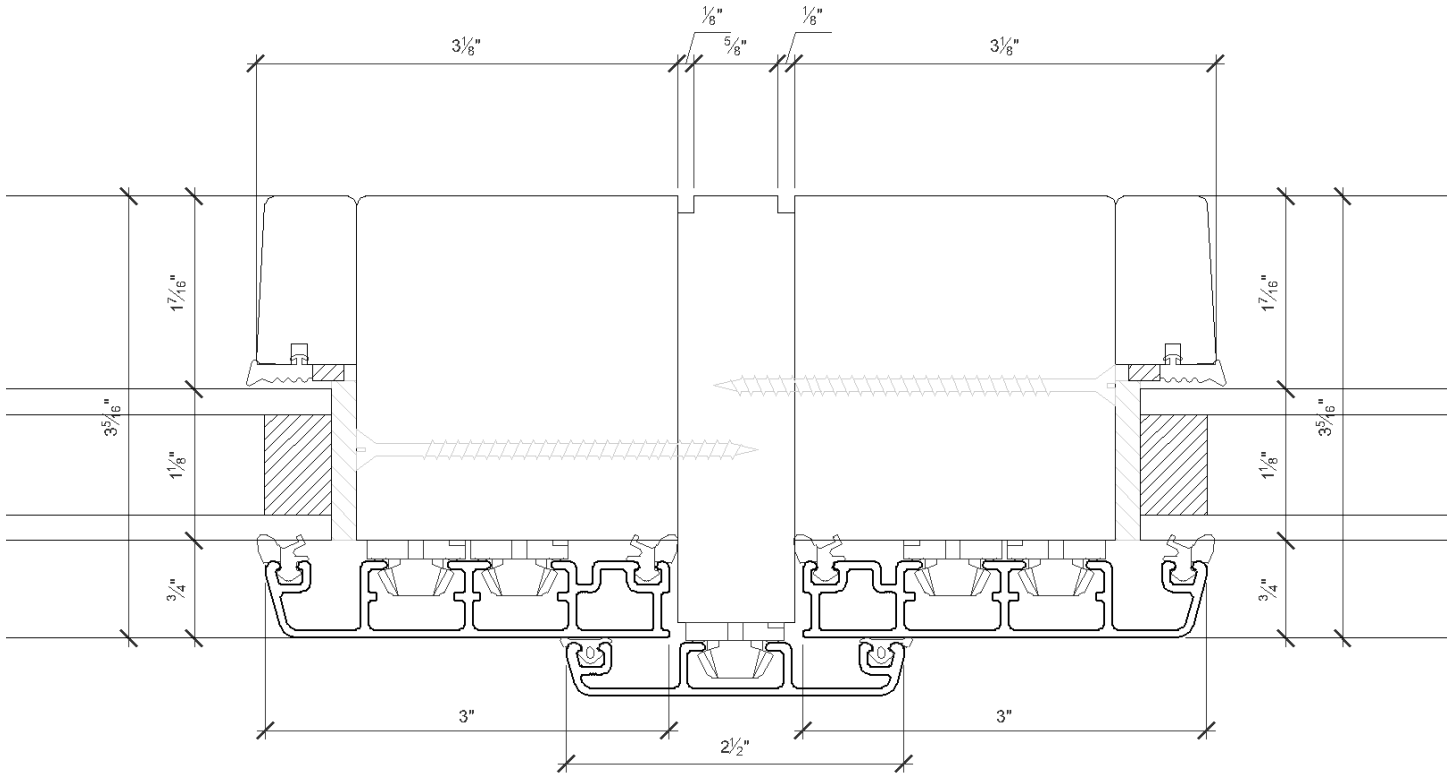

EXTERIOR

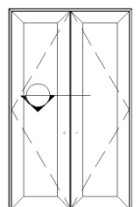

Contemporary SDL Detail

