



by PACIFIC ARCHITECTURAL MILLWORK

Pivot Door W6400

(rev. 02.06.18)

Pivot Door W6400

Section Contents

Product Overview	3
Introduction	3
Hardware Options	3
Glazing Options	3
Wood Species	3
Other Options.....	3
Product Parameters	3
In-Swing: Elevation.....	4
In-Swing: Plan Section – Closed Position	5
In-Swing: Plan Section – Open Position	6
In-Swing: Vertical Section	7
In-Swing: Head Detail.....	8
In-Swing: Sill Detail.....	9
In-Swing: Left Jamb Detail.....	10
In-Swing: Right Jamb Detail	11

Product Overview



Introduction

For a contemporary take on traditional hinged doors, Reveal Windows & Doors offers the W6400 all-wood Pivot Door. Rather than swinging from hinges that are mounted on the edge of the panel, these doors utilize a heavy-duty pivot hinge that can be edge-mounted, center-mounted or offset from the edge. This re-distribution of weight allows for oversized operable panels, with frame sizes of up to 10'H and over 5-1/2'W.

The all-wood construction provides nearly endless options for customization, including custom stile and rail sizes, mid rails, true divided lites, and raised or flat wood panels. An optional bottom threshold includes the recessed pivot already in place, which makes installation easier.

Hardware Options

Standard pivot hardware uses bottom-mounted Rixson® pivot hinges and top guides, or recessed Rixson® “buckets” for heavy-duty applications. For edge-mounted applications, additional intermediate hinges are installed as needed.

A variety of finish handle sets and pull hardware is available, including exterior key locks for secure entry systems.



Glazing Options

Standard glazing for the optional glass door panel uses 3/4" overall Argon-filled tempered insulated glass with a Low-E² coating for UV resistance and improved thermal performance. Custom glazing, tinted glass, wood flat panels, and wood raised panels are also available.

We offer two different standard glass stops/edge details:

- Contemporary (Square)
- Traditional (Ovolo)

See the General Info section for more details.



Wood Species

Our standard wood species are the following:

- Pine
- Vertical Grain Douglas Fir
- African Mahogany

Alternative and exotic wood species are also available. See the Wood Species page in the General Info section.

Other Options

The wood pivot door is available with optional pre-finishing, custom grille patterns, and raised wood panels.

Contact Reveal Windows & Doors for additional options and customization.

Product Parameters

Max Frame Height	120"
Max Frame Width	67-3/4" (Dependant on Panel Width and Pivot Placement)
Min Frame Height	72"
Min Frame Width	25-3/4"
Panel Thickness	2-1/4"
Min Stile Width	5-1/2"
Min Jamb Depth	Out-Swing: 6" In-Swing: 6"

In-Swing: Elevation

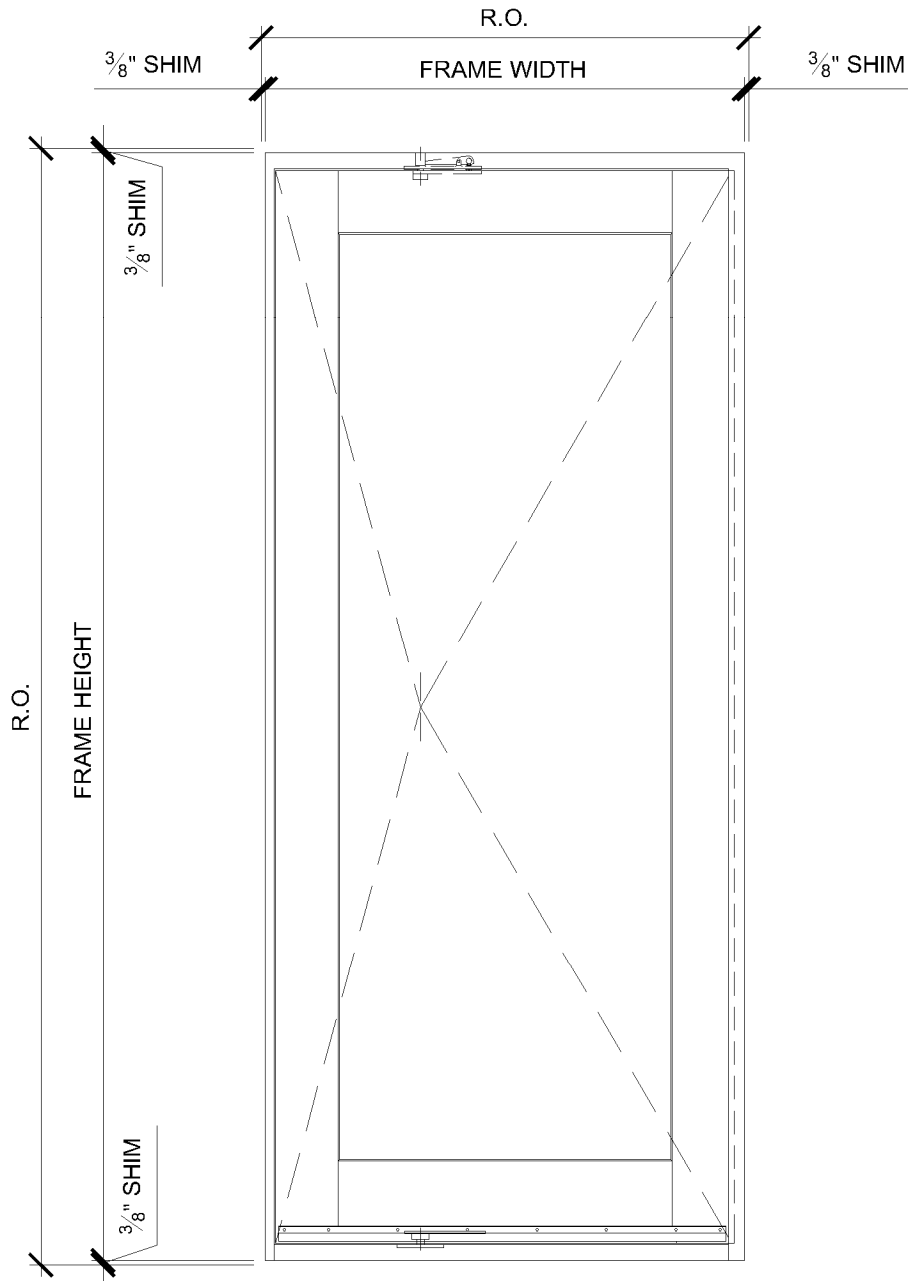

In-Swing: Plan Section – Closed Position

TDL and custom muntin profiles available.

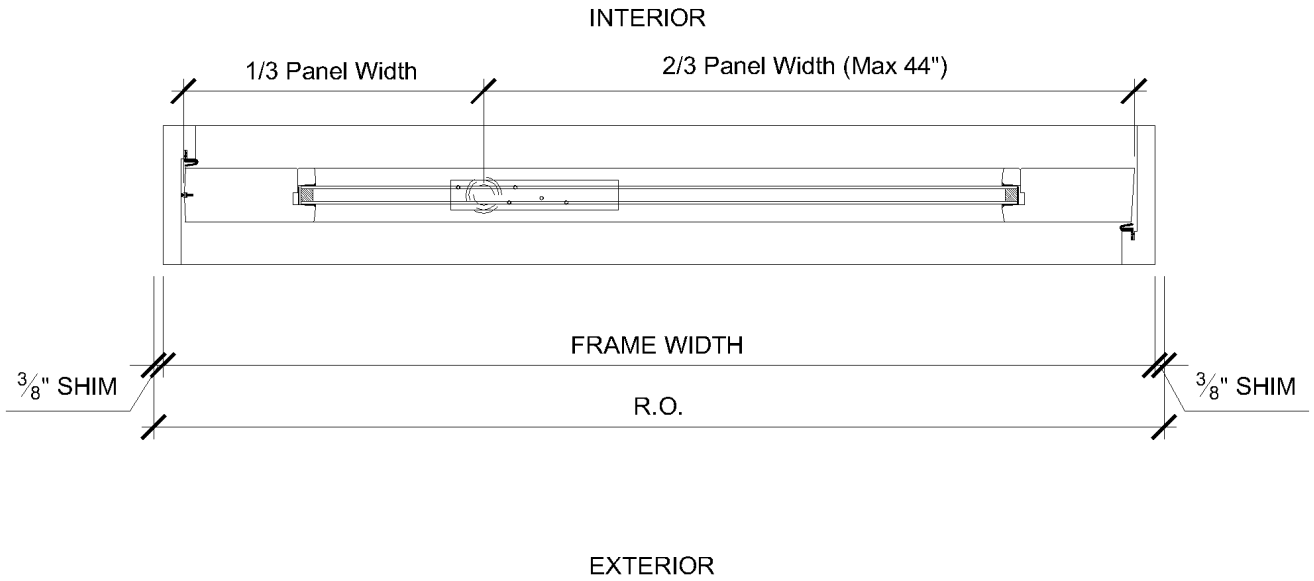

In-Swing: Plan Section – Open Position

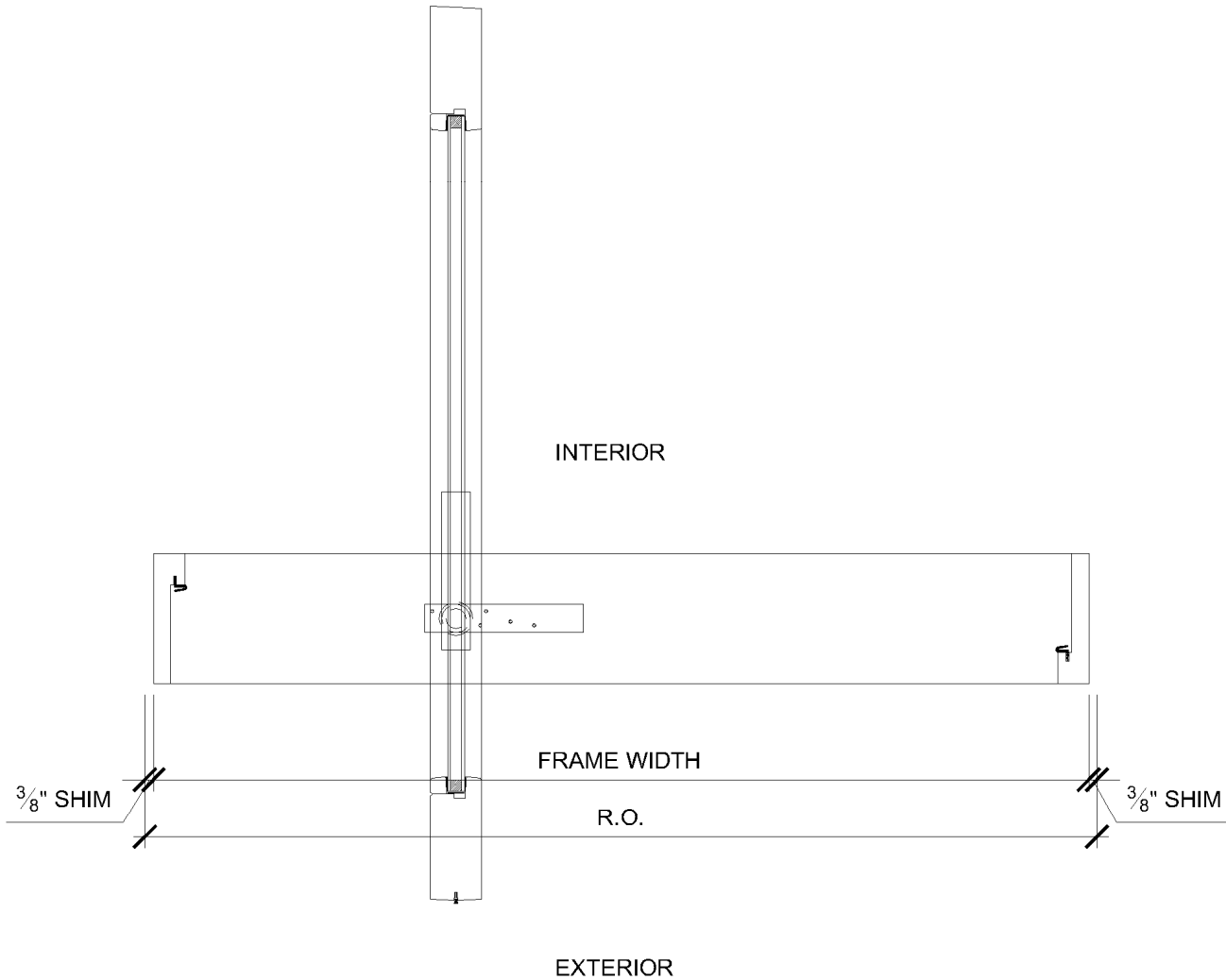

In-Swing: Vertical Section

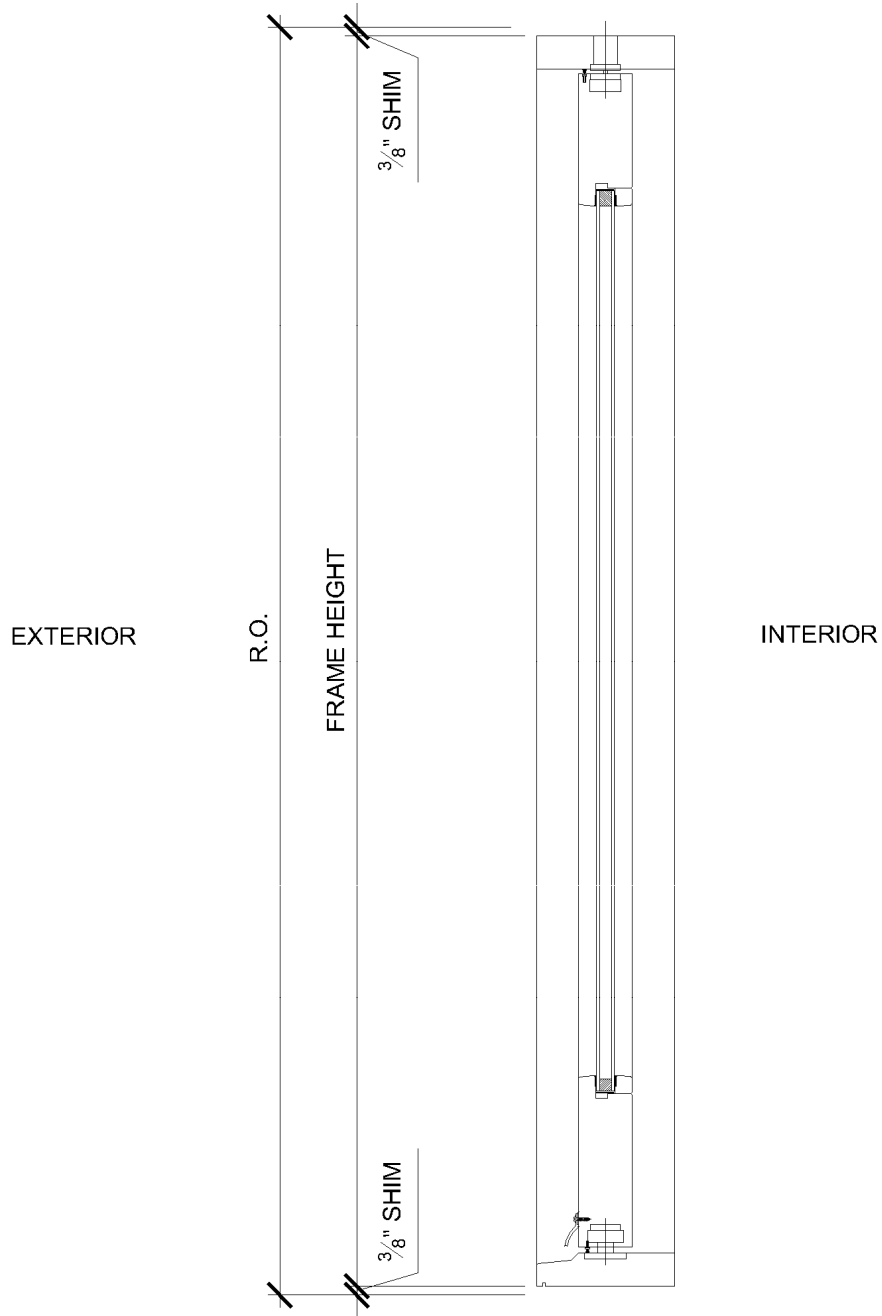

In-Swing: Head Detail

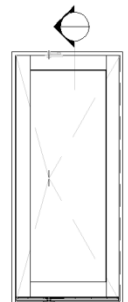
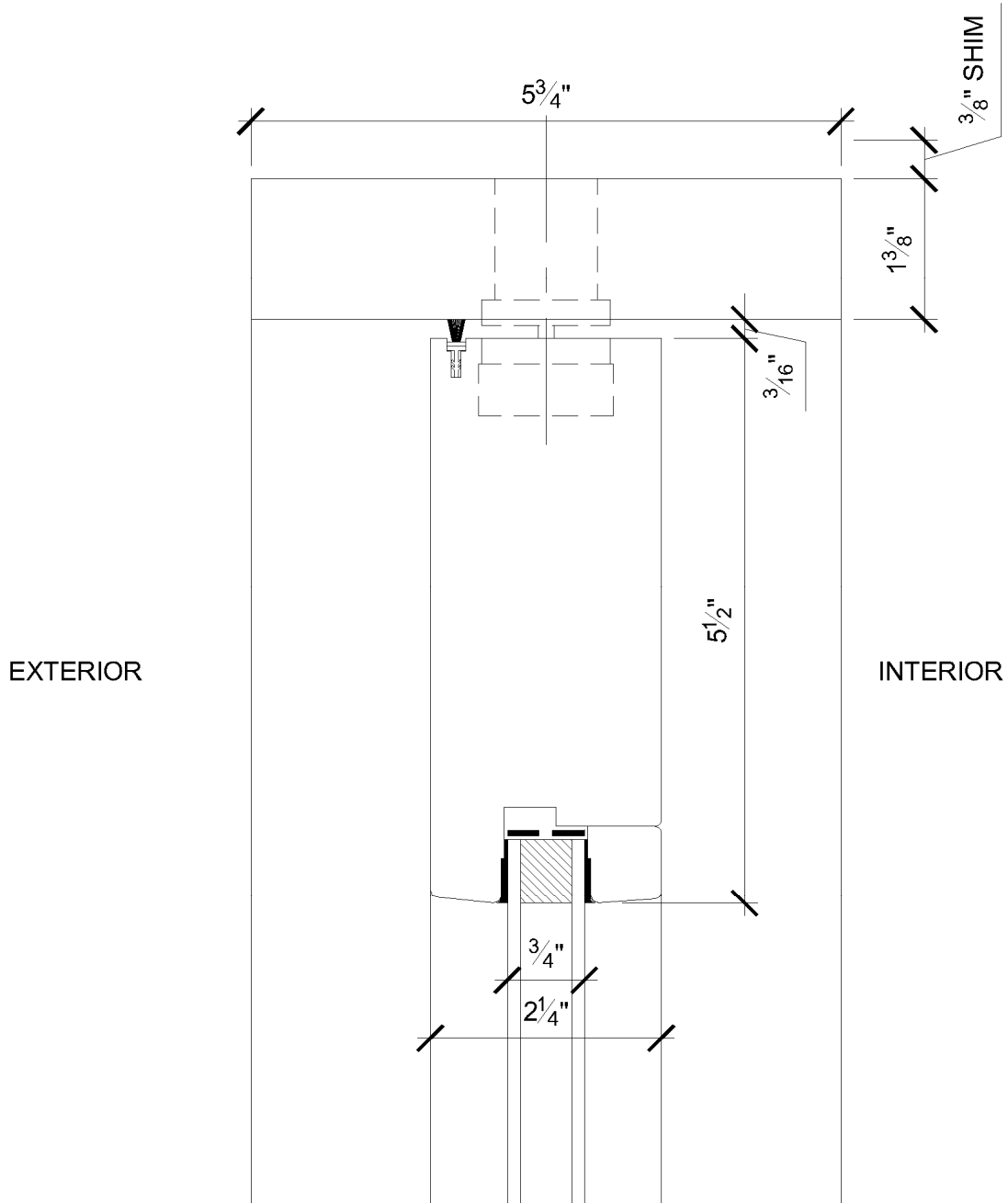

In-Swing: Sill Detail

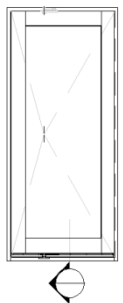
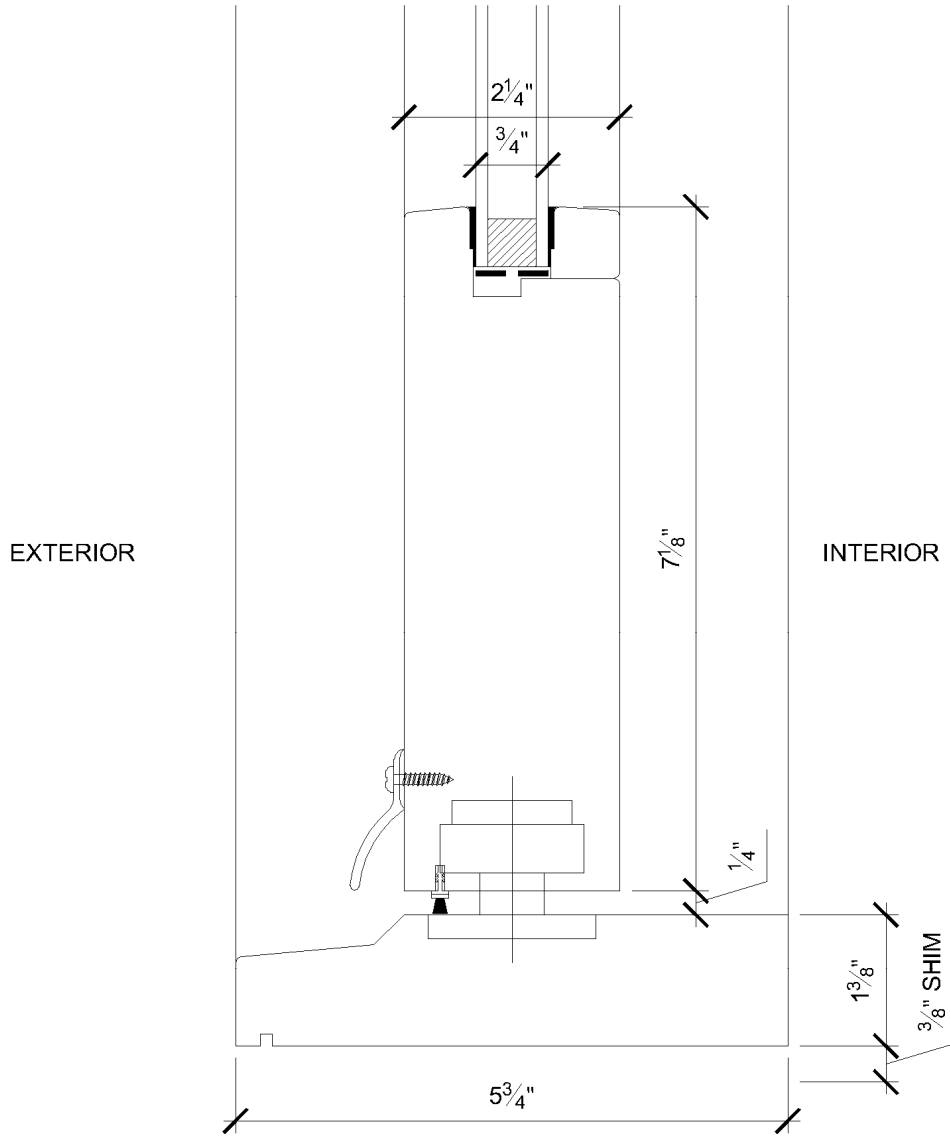

In-Swing: Left Jamb Detail

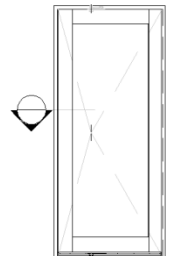
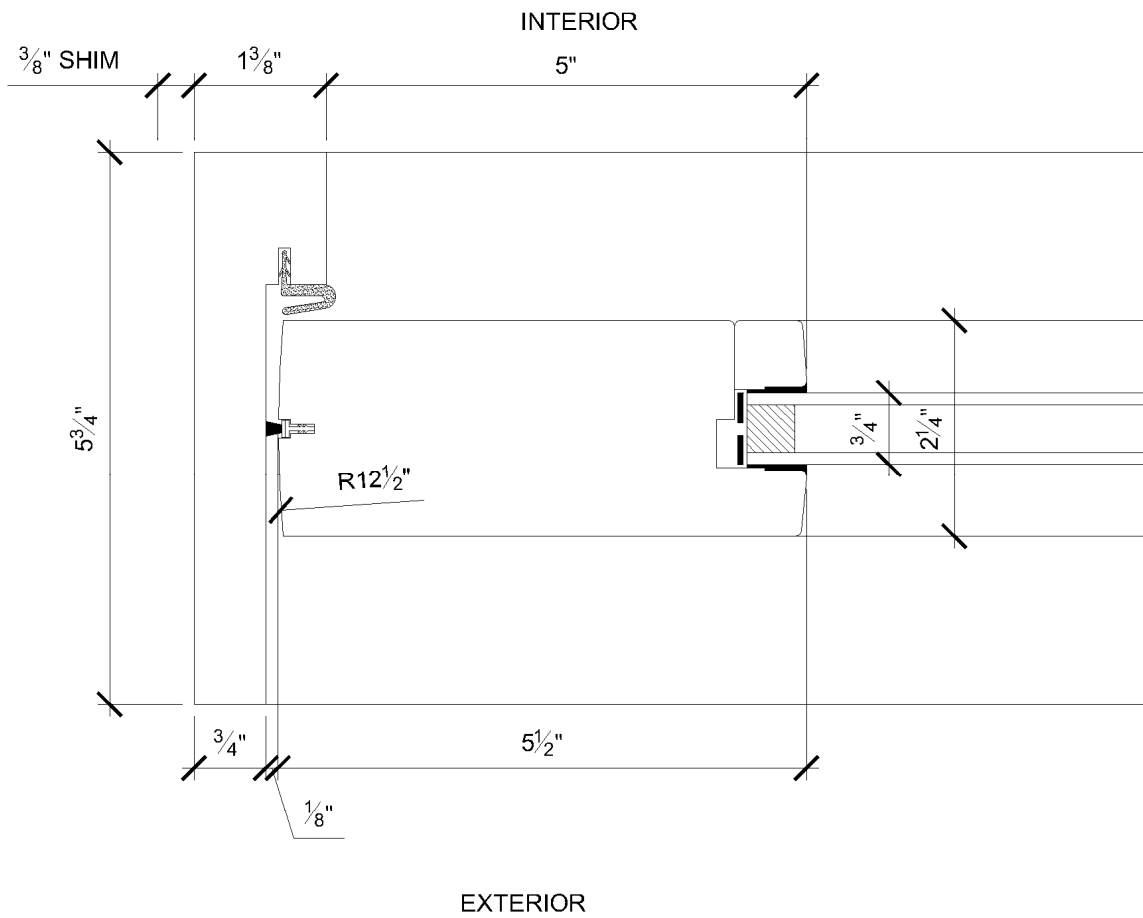

In-Swing: Right Jamb Detail

